

यांत्रिक अनुदेश Engineering Instructions for

House Wiring for Fiber To The Home (FTTH)

प्रलेख संख्या Document No.	:	EI/ACCESS NETWORK/11-12/ 13
पृष्ठसंख्या No of Pages.	:	18
जी आर का संदर्भ GR reference	:	NIL
संशोधन क्रमांक (यदि कोई) Amendment No. (If any)	:	NIL
पृष्ठ संशोधित Page Nos. Amended	:	NIL
जारीकर्ता Issued By	:	Telecom Quality Assurance circle, Bangalore
अनुमोदित Approved by	:	The CGM, TQA circle, Bangalore
जारी करने का दिनांक Date of Issue	:	11-08-2011
Written by	:	QA Circle
Expert Comments	:	Approved by BSNL CO vide letter no. BSNL/ SECTT/ 101/ MCB/ EXTRACT/ 06 dt. 01.08.2011.

Restricted use by BSNL Employees only

All efforts have been made to incorporate all relevant up to date information available, any discrepancies or need for addition or deletion is felt necessarily may please be intimated to this office for further improvement, on E-Mail Id cgmtqa_ei@bsnl.co.in (or) cgmtqa.ei@gmail.com



मुख्य महा प्रबंधक का कार्यालय
दूरसंचार गुण आशवासन परिमण्डल
दूसरा मंजिल, संचार काम्प्लेक्स,
डब्ल्यू एम एस काम्पौण्ड, ९ व मुख्य
रास्ता, ५ व ब्लॉक, जयनगर बेंगलूर –
५६० ०४१

**Office of Chief General Manager
Telecom Quality Assurance circle**
II Floor, Sanchar Complex,
BSNL-WMS Compound, 9th Main,
Jayanagar 5th Block, Bangalore - 560 041
Tel: 91 80 26533100 Fax: 91 80
26530681
Visit us at www.qa.bsnl.co.in

DISCLAIMER: FOR INTERNAL CIRCULATION AMONG BSNL EMPLOYEES AS A GUIDELINE FOR INSTRUCTIONAL PURPOSE.

CONTENTS

Clause No.	Description	Page No.
1.	Scope of the Document	3
2.	Introduction	3
3.	Passive Optical Network (PON) Architecture	3
4.	Type of FTTH customer provisioning in BSNL	4
5.	Installation Guidelines	5
6.	Hardware, accessories & testing equipments, required for FTTH installation	10
7.	Typical example of BSNL FTTH sites	11
8.	Cost Analysis for FTTH Customer provisioning	15
9.	Precautions to be taken for the extra length of Fiber laid in case of connector broken or faulty	16
10.	FAQs	17
11.	Abbreviations	18
12.	References	18

1. Scope of the Document:

This Engineering Instruction describes about the House Wiring for Fiber-to-the-Home (FTTH) in detail.

2. Introduction:

Fiber-to-the-Home (FTTH)

“Fiber-to-the-Home” is defined as a communications architecture in which the final connection to the subscriber’s premises is Optical Fiber. The fiber optic communication path is terminated on or in the premise for the purpose of providing multiple communications to a subscriber or many subscribers. In order to be classified as FTTH, the access fiber must cross the subscriber’s premises boundary and terminate

- inside the premises, or
- on an external wall of the subscriber’s premises, or
- not more than 2m from an external wall of the subscriber’s premises.

FTTH services generally deliver several applications such as data, voice and video, popularly known as “Triple-play Service”.

With the launch of FTTH technology Bharat Sanchar Nigam Limited (BSNL) can offer High speed Broadband access up to 1000 Mbps and plethora of services based on Triple play services like IPTV, HDTV, 3DTV, Video on demand, Bandwidth on Demand, Video conferencing, Interactive gaming, and several other VAS which are possible through FTTH. The optic fiber technology can deliver world class Triple Play experience to the consumers. Earlier BSNL launched FTTH in Jaipur, Ahmadabad, Hyderabad, Bangalore, Chennai, and Coimbatore and also announced that it will soon launch these services across the country in phased manner. BSNL in this direction has come up with different revenue sharing models with different vendors like Aksh, Alphion, Kiran Infra etc to implement its FTTH projects.

3. Passive Optical Network (PON) Architecture:

It is called Point to Multi Point (P2M). PON is a point to multipoint (P2M) network. Each customer is connected into the optical network via a passive optical splitter, therefore, no active electronics in the distribution network and bandwidth is shared from the feeder to the drop. The advantage of FTTH PON is the fact that they use purely optical passive components that can withstand severe and demanding outside plant environment conditions without the need to

consumer energy between in the central office exchange and the customer premises. The benefit to telecom operators is that low maintenance requirements of these passive optical components will significantly reduce of the cost of upgrades and operating expenditures. Passive systems utilize a common shared connection with the centralized electronics. PON architecture uses unidirectional splitters. PON FTTH solutions are driven by two key standards: FSAN/ITU and EFMA/IEEE, and solutions can be built with either standard. The PON architecture can reduce the cable cost as it enables sharing of each fiber by many users. Typical PON architecture is shown in the figures below.

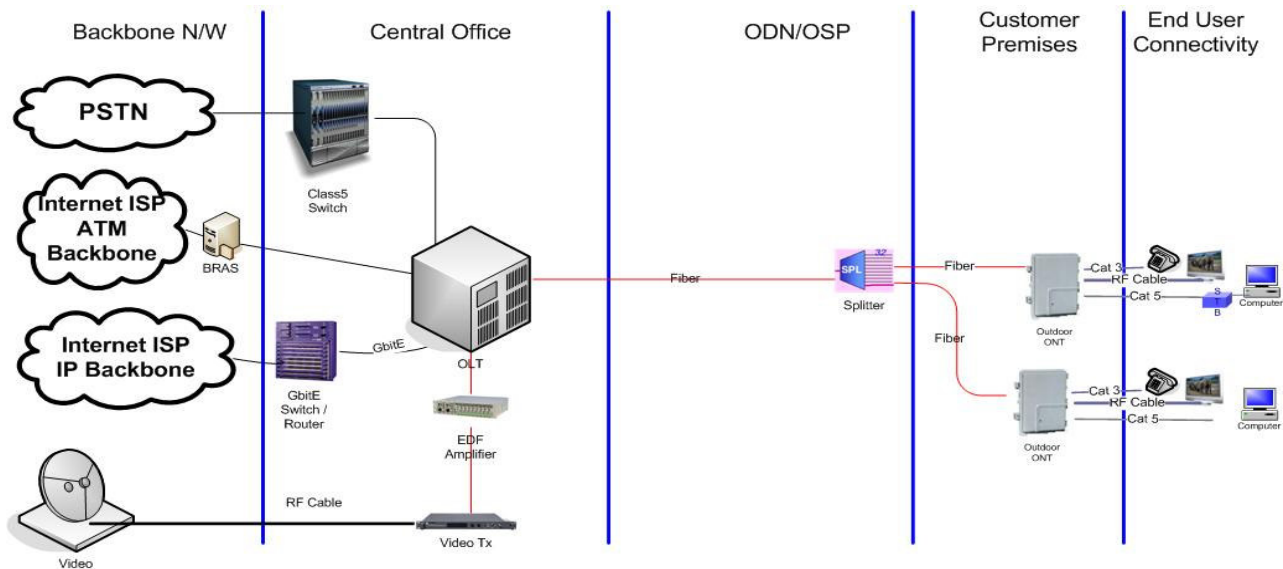
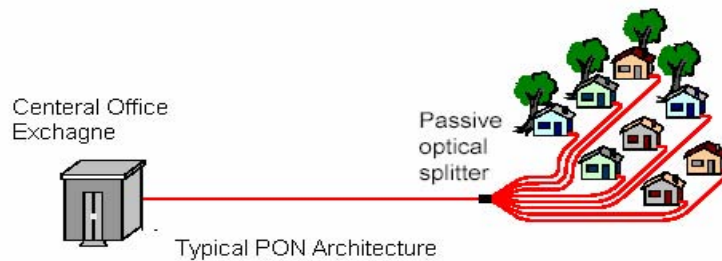

Typical PON network Architecture

4. Type of FTTH customer provisioning in BSNL:

The FTTH connectivity to the end-user can be provided in the following methods:

- Customer provisioning and installation done by BSNL – in this case, the OFC can be extended by utilizing the PVC conduits presently available or using additional conduits

and casing and capping wherever necessary in both the case of Villas and MDUs in the initial phase. When there is a increase in the number of subscribers and growth in the demand, the future installations and existing subscribers can be shifted to micro duct based installations in the phased manner.

- In the revenue-sharing mode floated through EOI, the vendor shall carry out the installation and maintenance of the FTTH customer provisioning through the micro-duct. Micro duct supply, installation will be borne by the vendor.

5. Installation Guidelines

Installation of house wiring inside the building can be divided in to 3 broad categories:-

1) Entry and termination of leading in Optical Fiber Cable inside the building.

<u>Optical Link Budget of GPON based FTTH</u>				
<u>Formula</u>				
Cable length in km x Cable Loss 0.34 dB / km + 0.15 dB x # of Connector + 0.05 dB x # of splices + 3dB as Margin of Error				
Mean launched power range at OLT PON port:			1.5 to 5	dBm
Minimum Receiver Sensitivity of ONT:			-27	dBm
<u>Note:</u> For calculation, Minimum Mean launched power at OLT PON port of 1.5 dBm is taken:				
Connectors: FTB output - 2, Splitter input -2, ONT - 1				
Splitter (Commonly used) : 2: 4 = 7.4 dB, 1: 8 = 10.5 dB				
<u>Scenario A DISTANCE 2 Kms</u>				
2 x 0.34 dB/km + 0.15 dB x 5 + 0.05 dB x 4 + 3 dB =			-4.63	dBm
Input power at ONT =			-3.13	dBm
With 2:4 & 1: 8 Splitters			-21.03	dB
<u>Scenario B DISTANCE 10 kms</u>				
10 x 0.34 dB/km + 0.15 dB x 5 + 0.05 dB x 4 + 3 dB =			-7.35	dBm
Input power at ONT =			-5.85	dBm
With 2:4 & 1: 8 Splitters			-23.75	dB

Scenario C DISTANCE 15 kms			
15 x 0.34 dB/km + 0.15 dB x 5 + 0.05 dB x 4 + 3 dB =		-9.05	dBm
Input power at ONT =		-7.55	dBm
With 2:4 & 1: 8 Splitters		-25.45	dB

2) Distribution of patch cords from splitter at the basement/ground floor to each floor.

3) Entry in the house /apartment, wiring inside the house and ONT installation.

Brief description of each of these categories is as follows:-

1) Entry and termination of leading in Optical Fiber Cable inside the building.

a) The leading in OF cable is to be tapped from the nearest Manhole of the OAN network. The size of the OF cable can be chosen based on the number of subscribers to be provisioned in the building/gated communities. Here it can be mentioned that each fiber can undergo 32 splits for providing 32 FTTH subscribers. Since each optical PON port is having 1+1 protection at the OLT, It is advisable to use 2XN type of splitter for the first split. The two inputs of the splitter from the OLT can be fed from two different directions if available. Hence for each 32 subscribers 2 fibers can be planned to provide continuity of service in the event of break in one of the fibers .The capacity of leading in OF cable can, therefore, vary from 6F to 24F.It is significant to mention that if the distance from the nearest manhole to the building is in excess of 50 meters, then the OAN network can be tapped from the nearest convenient point to the building by making a joint. This will result in savings by way of laying charges/reinstatement charges which is in the tune of about 3000 Rs per subscriber for a distance of about 300 meters assuming the charges levied by local body is around Rs 300/meter .

b) The Lead in OF cable is terminated in the wall mounted Fiber termination box (FTB) confirming to TEC GR supplied by telecom Factory Mumbai) at the basement or at the suitable entry point of the building/house.

- Fiber Termination Box: 8/12/24 Fiber terminations (in house)



Note:

1. FTB is supplied by BSNL Telecom Factory Mumbai.

- It is suggested to introduce provision in the FTB output for connecting pigtails with zero db connectors for point of flexibility as shown below

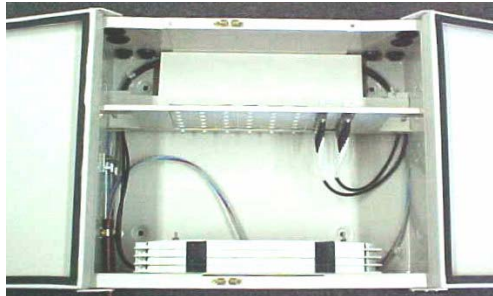

The patch cords (G657 type supplied @ 100 meters per port along with FTTH equipment) are spliced with OF cable in the FTB and are terminated on the splitter .

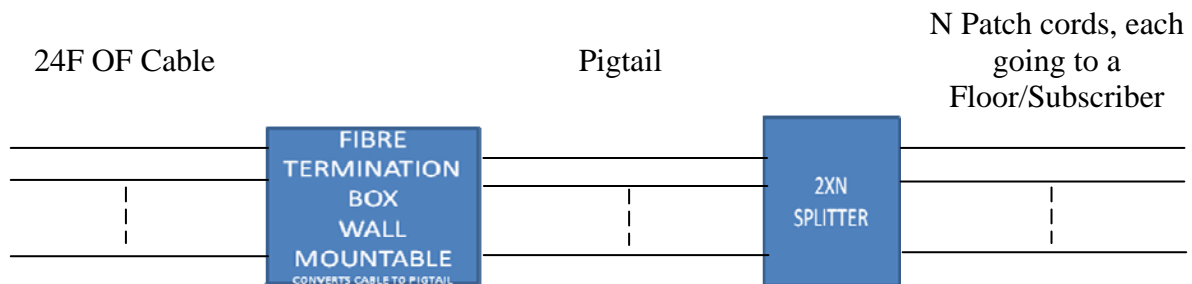

The splitter is a passive device which accepts one or two fibers and gives out 2/4/8/16/32/64 optical outputs. The output of splitter is provided with SC-UPC (Blue) type connectors. This patch cord can be crimped in the field and the patch cord conforms to G-657 standards. This cable is available in coils of more than 100 meters. Hence, depending on the floor length, the patch cord can be prepared at site.

If the number of flats in the building is 32 or less, the splitter can be installed adjacent to TJB. This will not necessitate installation of multiple splitters in each floor. Care should be taken to protect the splitter from moisture and dust. The typical losses of various splitters are shown in Table-I.

Type of splitter	Insertion Loss in dB
1:2	4.0
1:4	7.1
1:8	10.5
1:16	13.8
1:32	17.1
1:64	20.5

2:4	7.4
2:8	11.0
2:16	14.6
2:32	17.8

One fiber can give a maximum of 32 Split. If the number of flats in the building is more than 32 in each floor, one fiber can be terminated in each floor, and depending on the number of flats in each floor, suitable splitter can be provided.

The splitters may be used for utilizing the same fiber for multiple customers. The location of splitter will depend on the total no. of fiber (i.e. no. of flats in the building and of course on the characteristics of the splitter. There may be requirement of only one splitter for the whole building if the building is small. If the no. of flats in a multi-story are more, even we may have to plan more splitters may be floor wise.

2) Distribution of patch cords from splitter at the basement/ground floor to each floor.

a) Provision of sufficient space and arrangement for distribution of patch cable to different floors has to be done. For these purpose vertical risers to take the feeder cables to different floors has to be identified. And in each floor distribution of the cables through the external/ internal conduits is required.

In the situation of risers not being provided, the cable may be brought to each floor via Conduit/PVC pipe of suitable dimension. The ISI mark PVC pipe of required size / diameter shall be fixed along the duct / shaft of the building or suitable The PVC pipe shall be fixed on the wall / runway with proper clamps / saddles with a maximum spacing of 50 cms. The PVC pipe shall be drawn from the cellar / ground floor to the respective floors of the building.

If conduits are concealed, then those parts of it should be accessible wherever there is a bend, so that fiber cable can be drawn without damaging the fiber.

If no concealed dedicated conduits with access on each bend are provided, then rectangle channels may be used, so that there is no undue pressure on fiber and it can be accessible easily for the distribution of fibers on each floor/ inside the flat/ shop, It is again reiterated that in case of external wiring, exact type of conduit/ channel can be decided in tune with the aesthetics of the building plus the consent of the owner/society.

Alternatively single micro ducts of dimensions (7.5/5.5mm) can also be used for in- floor distribution of single patch cord. It can be installed inside the existing concealed conduits and subsequently patch cord can be pulled inside it. It offers the advantage of zero bends and permanently lubricated inside surface resulting in very easy installation of fiber without any break. Single micro ducts can also be installed over the wall surface with available clamps and accessories in the market. It has a cost comparable to the PVC conduits and rectangular channels.

3) Entry in the house /apartment, wiring inside the house and ONT installation.

Entry can be made in the following manner:-

- a) Through the wet raisers by fixing normal PVC pipes available in the market may be, in the kitchen or into the bathroom, from that point through casing capping we take the fibre to the hall/bed room with the co-operation of the flat owners only.
- b) Through the vertical axis along the stair case and enter in to the hall and keep the UPS and ONT near the shoe rack/behind the main door where 5 Amps socket is available.
- c) If conduits are concealed, then those parts of it should be accessible wherever there is a bend, so that fiber cable can be drawn without damaging the fiber.
- d) If no concealed dedicated conduits with access on each bend are provided, then rectangle channels may be used, so that there is no undue pressure on fiber and it can be accessible easily for the distribution of fibers on each floor/ inside the flat/ shop, It is again reiterated that in case of external wiring, exact type of conduit/ channel can be decided only after keeping the look of the building and how well it can be integrated with it, the consent of the owner/society. The surface shall be painted and brought to original finish.
- e) Alternatively single micro ducts of dimensions (7.5/5.5mm) can be used for in floor distribution of single patch cord. It can be installed inside the existing concealed conduits and subsequently patch cord can be pulled inside it. It offers the advantage of zero bends and permanently lubricated inside surface resulting in very easy installation of fiber without any break. Single micro ducts can also be installed over the wall surface with available clamps and accessories in the market. It has a cost comparable to the PVC conduits and rectangular channels.
- f) The patch cords before terminating in to the ONT are coiled and housed inside the face plate which is wall mounted box having a provision to store extra coils of patch cord for maintenance .It also helps to avoid pulls and pressure on the main patch cord coming from splitter at the basement/ground level.

- Face Plate for coiling extra patch cord at user end for maintenance



Specification for Face plate used for coiling extra patch cord in FTTH Customer Home

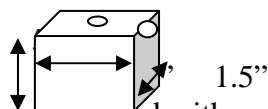

Flap type Box for coiling extra patch cord with a provision for four-side opening in the sides for patch cord connectivity.

BSNL Logo may be included .

Dimension of Width x Height x Depth = 5" x 5" x 1.5"

6. Accessories required for FTTH Installation

Hardware, accessories & testing equipments, required for FTTH installation:

Sl. No:	Description
1	OFC from BSNL Exchange
2	Fiber Distribution Box
3	One pair of Fiber per Splitter
4	Splitter1 Types -1:4, 2:4, 1:8, 2:8, 1:16, 2:16, 1:32, 2:32
4a	Splitter-2 if required
4b	Splitter-3 if required
5	Micro duct in Future path
6	Micro Fiber Cable
7	Couplers
8	ONT with Telephone port (RJ-11), Ethernet Port (RJ-45), RF Video Port
II	ACCESSORIES & TEST EQUIPMENT
1	OTDR
2	Optical Fiber splicer

- Fiber Termination Box: 8/12/24 Fiber terminations (in house)



- Splitter (already supplied) 1:4, 2:4, 1:8, 2:8, 1:16, 2:16, 1:32, 2:32 types

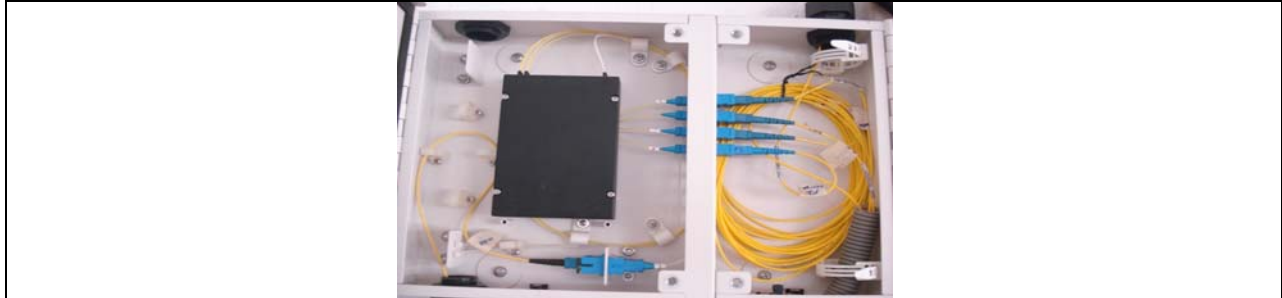

- Face Plate for coiling extra patch cord at user end for maintenance



- PVC conduits and its accessories, casing and capping.
- Patch cord(100 m per port already supplied)

7. Typical example of BSNL FTTH sites:



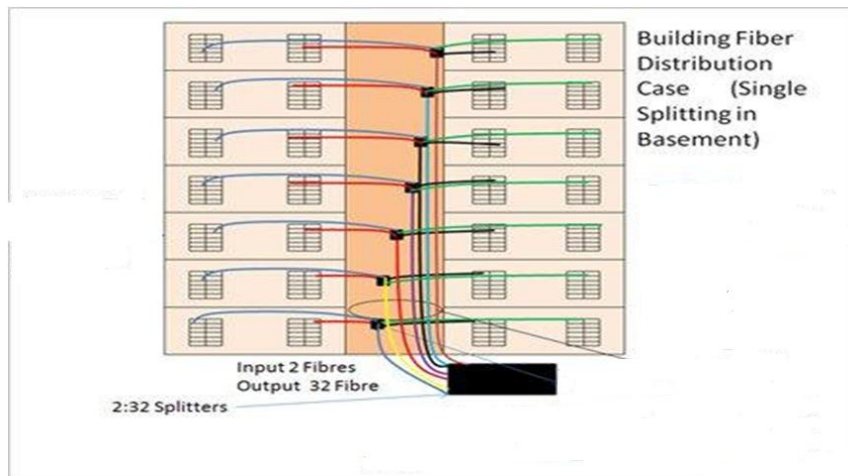

Some of the typical scenarios of fiber distribution implemented in the BSNL sites at Coimbatore and Bangalore are as under:

Case 1.Single splitting basement:

The typical diagram is as under:



High-rise Flat/Apartments Scenario

<p>Daksha Apartments, Thondamuthur Road, Coimbatore</p>			
<p>OLT Equipment at Exchange</p>	<p>FDMS start point in the Flat with 2:4 and further 1:8 splitter</p>	<p>FDMS distribution in a Block along with wet raiser</p>	<p>FTTH termination, ONT at the customer end</p>
			



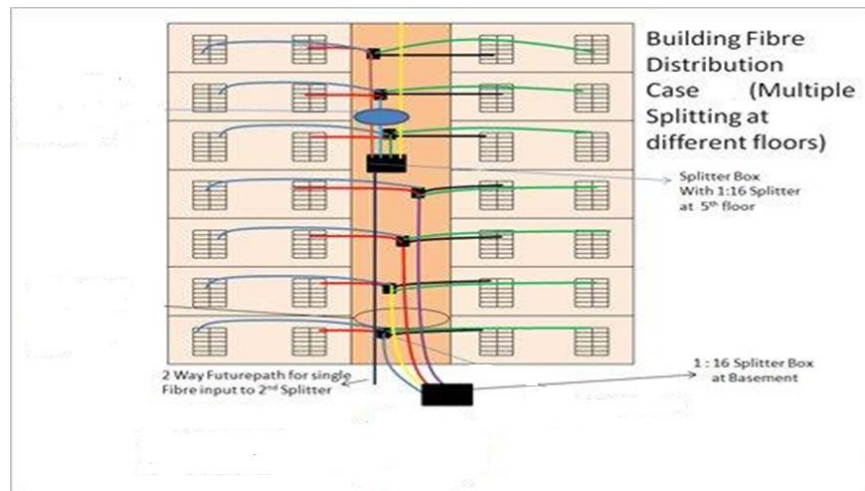

Case 2. Multiple splitting at different floors:

For this arrangement, the typical diagram is as under:



High-raise Flat/Apartments Scenario

<p>Manosaravor Apartments, Off. Trichy Road, Coimbatore</p>			
--	--	--	--

<p>OLT Equipment at Exchange</p>	<p>FDMS start point in the Flat Basement with a 2:4 splitter</p>	<p>FDMS distribution at the middle of a Block(3rd Floor) with a 1:8 splitter</p>	<p>FTTH termination, ONT at the customer end</p>
			

Case 3. Building fiber distribution for small buildings

The typical diagram is as under:

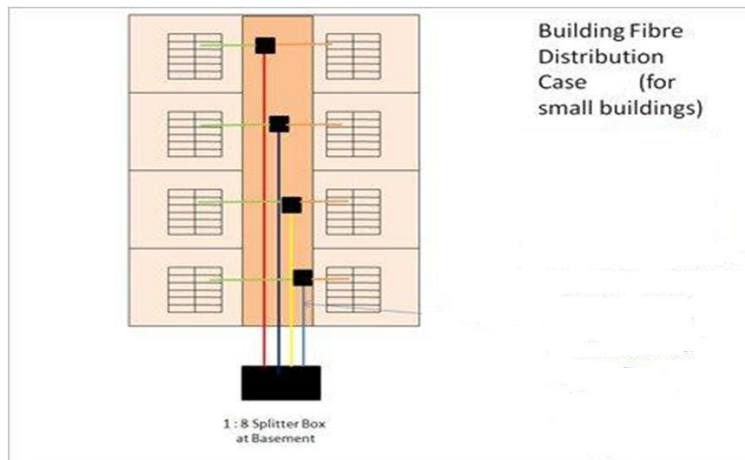

<p>High-rise Flat/Apartments Scenario</p>		
<p>PGP Village Apartments, Off. Trichy Road, Coimbatore</p>		
<p>OLT Equipment at</p>	<p>FDMS start point in the Flat</p>	<p>FTTH termination, ONT at</p>

Exchange	Basement with a 2:4 splitter and further 1:16	the customer end
		



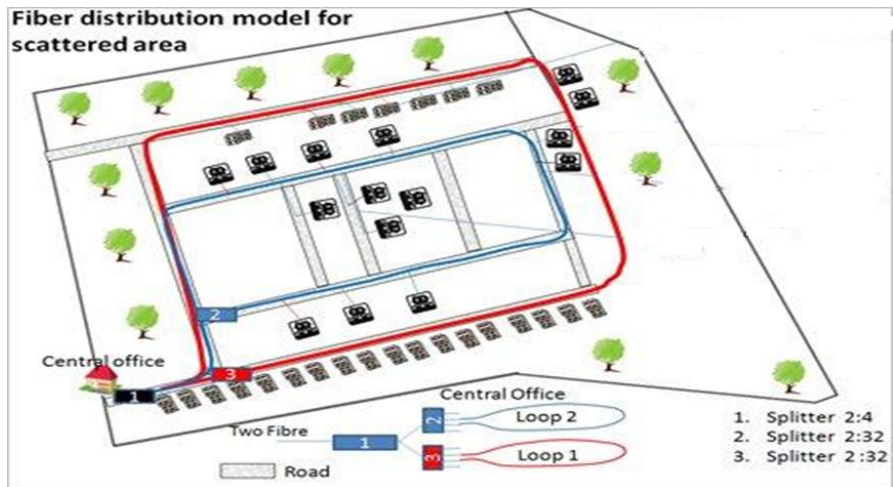

Case4: Fiber distribution for scattered area:

Typical diagram is as under:



**Gated Community Villas Scenario
Adharsha Palm Retreat, Bangalore**

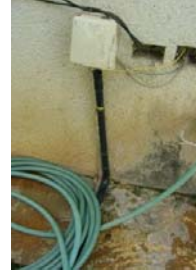

OLT Equipment at Exchange	Fiber Termination in Villa No. 1	Fiber splitted using 1:8 Splitter to cater 8 Villas	Fiber taken to a Villa using PVC pipes	Fiber taken into the Villa
				

8. Cost Analysis for FTTH Customer provisioning:

Scenario-1 Small Building

- Connecting 8 Subscriber
- FTB - 8 : Rs. 1200
Face Plate: Rs.100x 8 = Rs. 800
PVC Pipe: Rs. 10/Meter x 150 = 1500
Labour: Rs. 1000
Other accessories = Rs. 1000

Cost / House for FTTH = Rs. 5500/8 ~ Rs. 700

Scenario-2 Multi-Storey Building

- Connecting 32 Subscriber
- FTB - 8 : Rs. 1200
FTB – 24 : Rs. 1200
Face Plate: Rs.100x 32 = Rs. 3200
PVC Pipe: Rs. 10/Meter x 1000 = 10000
Labour: Rs. 10000
Other accessories = Rs. 5000

Cost / House for FTTH = Rs. 30600/32 ~ Rs. 1000

Rough calculations for laying of leading in OF cable in to the building:

- 6 F: Rs. 15/Meter
- 24 F: Rs. 26/Meter
- Trenching: Rs. 115/Meter
- Cable Pulling (Labour): Rs. 3/Meter
- PLB HDPE Pipe: Rs. 30/Meter

Approx. 800 Meter Main Fiber termination to building from nearest Man-hole:

800 (Rs. 26(24F) + Rs. 115(Trenching) + Rs. 30 (PLB HDPE Pipe)) = Rs. 1, 36, 800

When establishing a new FTTH network, the dominant cost component will inevitably be civil work, ducts, and cables. The cost of civil work and cables in the access segment escalates in the suburban and rural scenario, due to longer distances. Additionally, in rural settings, ducts and cables in the backbone segment result in a higher CAPEX than the whole deployment cost of FTTH in urban settings.

When deploying a FTTH infrastructure, all homes in a deployment area are connected with a fiber cable, independent of take-up rate. This means that the dominant cost component of civil work, ducts and cables is fixed. The result is that the more subscribers a FTTH operator can attain, the lower the cost pr. subscriber is. Another way of measuring the cost of FTTH is therefore per passed home, rather than per subscriber.

9. Precautions

General:

1. **Strict instructions should be given to the field staff/contractor not to use the internal electrical conduits for the FTTH house wiring purpose. Using electrical conduits will endanger the life of the customers as well as BSNL personnel.**

Precautions to be taken for the extra length of fiber laid to avoid connector getting broken or faulty:

1. Use small termination boxes locally fabricated along with zero db connectors, from which the pig-tail is extended to the splitter.

2. The drop Fiber connecting between both the splitters should have extra length of one meter at both ends for flexibility or if the connectors are broken we need length for connectorisation and testing.
3. To keep this extra length of Fiber neatly and safely we use small plastic boxes in the sub-offices and unused termination boxes near splitter ends.

10. FAQs:

1. What is Fiber-To-The-Home technology?

Fiber-To-The-Home (FTTH) technology is the delivery of information through pulses of light over a fiber optic network directly to the end-user. No other technology can match the extreme amount of information delivered by a 100% fiber optic system. LUS Fiber is the first community-owned 100% fiber optic network in Louisiana, and the only 100% fiber optic network in Lafayette.

2. How is Fiber-To-The-Home (FTTH) technology different than what I have now?

It's all in the infrastructure. LUS Fiber offers a 100% fiber optic connection to every home and business in the city, while companies using partial fiber systems still rely on copper wire to deliver signals over extended distances, leading to poor signal quality. Only a FTTH network can carry high bandwidth signals over long distances using light, which has no interference issues and will deliver superior products.

3. Why do I need fiber optic technology when the signals travel over my existing wiring once the information reaches my house?

Copper cabling is an efficient means of delivering information over very short distances. However, networks that rely on partial fiber-to-copper infrastructure are subjected to extreme bottlenecking of information due to a limited amount of available bandwidth. They are susceptible to interference of radio frequencies (RF) and must continuously "refresh" or strengthen the signal to deliver it to the consumer's home. FTTH networks have virtually

limitless bandwidth, which allows free flowing of information at the speed of light. Signals over fiber can travel greater distances without having to be refreshed and are not subject to RF interference.

11. Abbreviations:

FTTH: Fiber to the Home

BSNL: Bharat Sanchar Nigam Limited

OFC: Optical Fiber Cable

FTB: Fiber Distribution Box

ONT: Optical Net work terminator

ONU: Optical net work Unit

OLT: Optical Line Terminal

OTS: Open To Sky

AFM: Automated Fiber Management

OTDR: Optical Time Domain Reflectometer

ESON: Ethernet Switched Optical Network

APON: ATM Passive Optical Network

BPON: Broad band Passive network

12. References:

1. FTTH Council, Europe - <http://ftth2010.ontwikkelversie.nl/>
2. Aksh technologies, Bhiwadi
3. Kiran Infra, Jaipur